

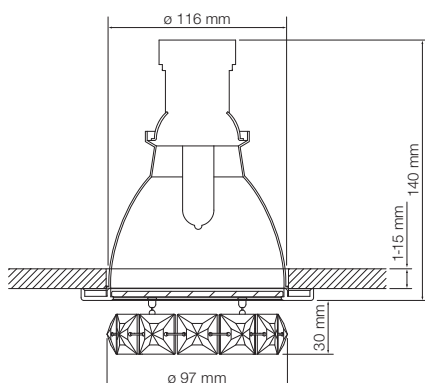









## Crystal Attraction RINGLET recessed ceiling luminaire



The warm halogen light plays with the circle made up of sparkling crystal squares and animates the ceiling with fine, symmetrical light reflections. At the same time Ringlet ensures uniform illumination of the space. Ringlet is an excellent luminaire for hotels, restaurants and similar representative spaces. It achieves optimum effect in rooms of two to three metres in height.



- Lamp type: high-voltage halogen lamp
- Lamp denomination: Osram Halolux Ceram 100 W
- Base: E27
- Voltage: 220 - 240 V
- Power: 100 W
- Depth of insertion: 140 mm
- Ceiling thickness: 1 - 25 mm
- Ceiling opening : Ø 116 mm

Product	Article number	Version
RINGLET	A.9950 NR ... 700 238	chrome